

EFR-8374

475-750HP



- ✓ Gamma-Ti Turbine Wheel
- ✓ Dual Ball Bearing Assy with Metal Cage
- ✓ Forged Milled Extended Tip Compressor Wheel
- ✓ Stainless Steel Turbine Housing
- ✓ Water Cooled Bearing Housing
- ✓ Large Internal Wastegate (where applicable)
- ✓ Compressor Recirculation Valve (a.k.a BOV)
- ✓ Boost Control Solenoid Valve
- ✓ Standard T3 Mounting Flange

Not included with turbo assemblies:

- Speed sensor
- Turbine outlet V-Band
- Turbine inlet gasket
- Oil drain gasket or drain port fitting

Turbo Frame Dimensions

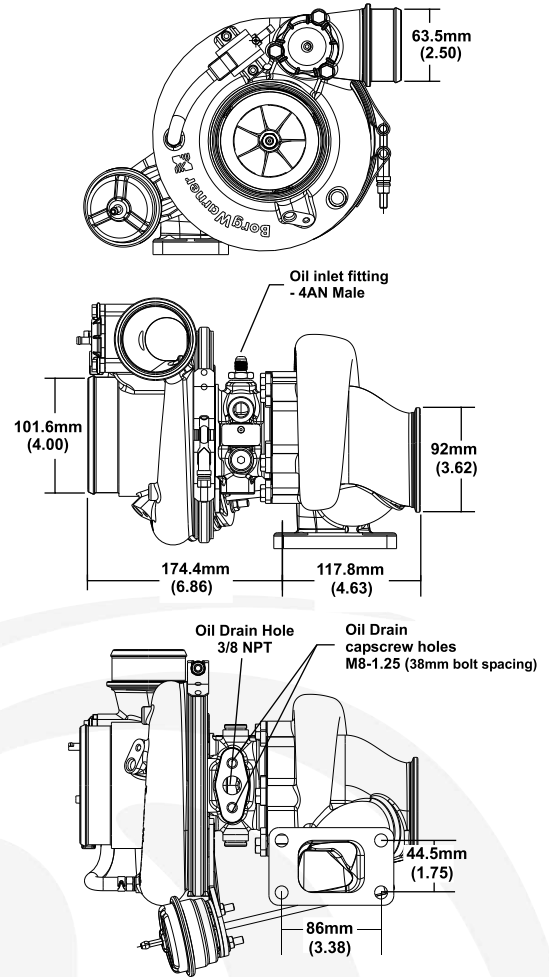

Compressor Map

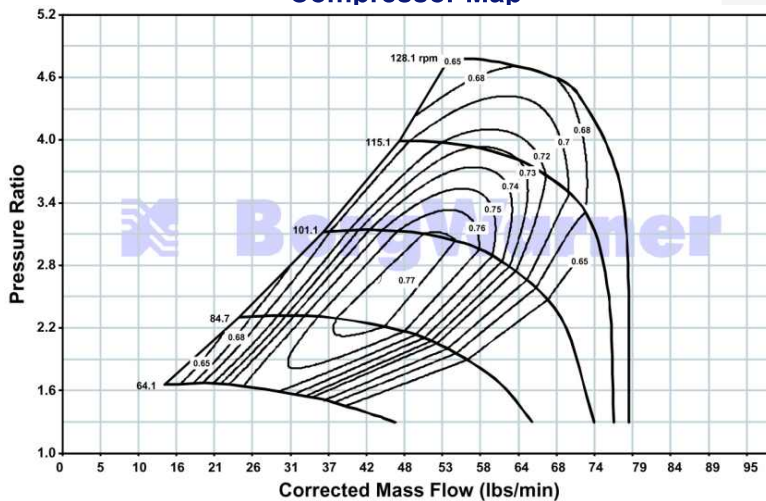

Super Core Configuration

The following parts are not included as part of the super-core assembly; turbine housing, assembly, clamp plate hardware, wastegate parts.

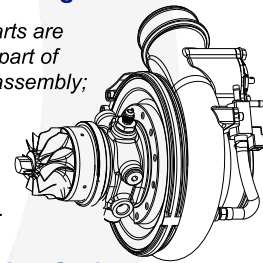

Turbine Housing Options

Turbine Housing Part Number	A/R	inlet flange shape	Housing Config
12741008000	0.83	T3	Single Scroll WG
12741008001	0.92	T4	Twin Scroll WG
12741019002	1.05	T4	Twin Scroll Non-WG

Turbo Part Number	Turbo Frame Size	Super Core Part Number	Comp. Whl O.D. (in)	Comp. Whl Inducer Dia (in)	Comp. Whl O.D.(mm)	Comp. Whl			Inlet Flange Config
						Inducer Dia(mm)	Turb. Whl OD(mm)	Turb. A/R	
179258	B2	179257	3.29	2.46	83.5	62.6	74.0	.83	T3