

EFR6758

275-450HP

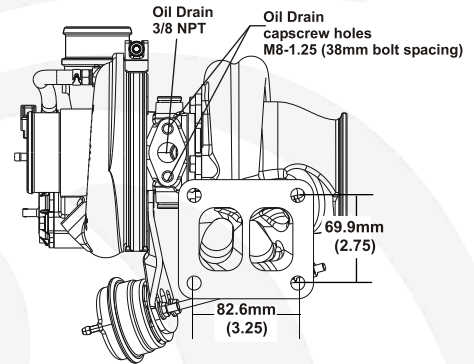

Turbo Frame Dimensions

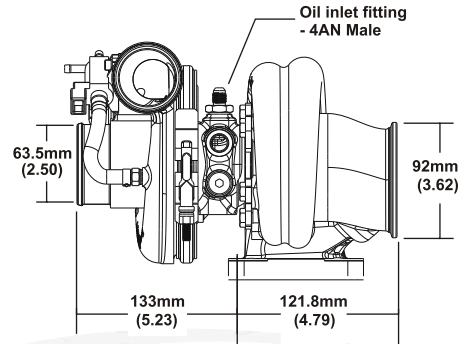
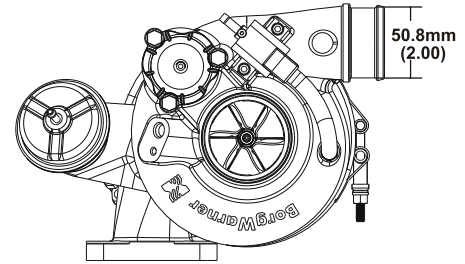
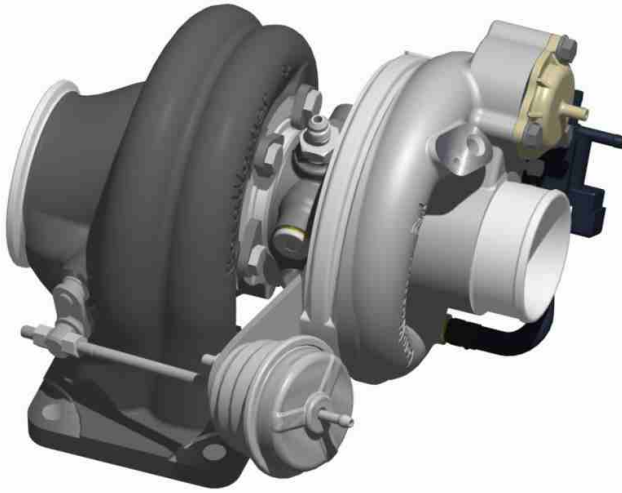

- ✓ Gamma-Ti Turbine Wheel
- ✓ Dual Ball Bearing Assy with Metal Cage
- ✓ Forged Milled Extended Tip Compressor Wheel
- ✓ Stainless Steel Turbine Housing
- ✓ Water Cooled Bearing Housing
- ✓ Large Internal Wastegate (where applicable)
- ✓ Compressor Recirculation Valve (a.k.a BOV)
- ✓ Boost Control Solenoid Valve
- ✓ Standard T4 Mounting Flange

Not included with turbo assemblies:

- Speed sensor
- Turbine outlet V-Band
- Turbine inlet gasket
- Oil drain gasket or drain port fitting

Compressor Map

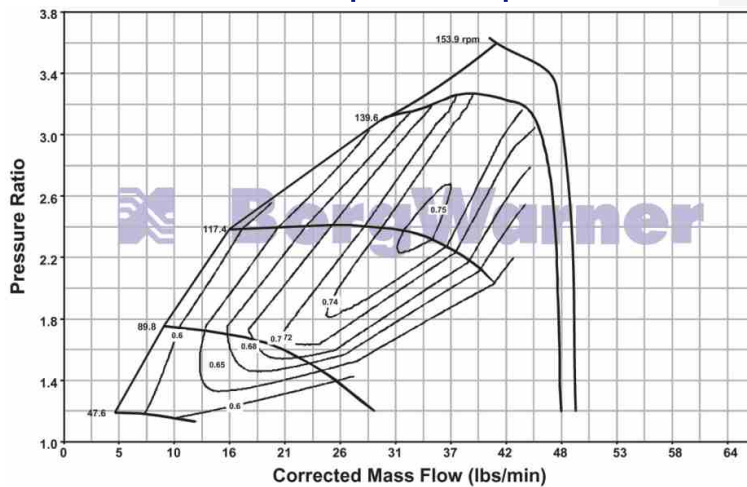

Super Core Configuration

The following parts are not included as part of the super-core assembly; turbine housing, assembly, clamp plate hardware, wastegate parts.

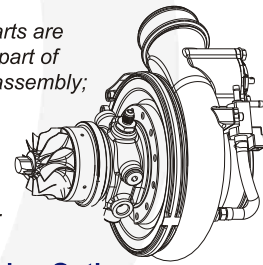

Turbine Housing Options

Turbine Housing Part Number	inlet flange A/R	shape	Housing Config
11581009006	0.64	T25	Single Scroll WG
11581009007	0.92	T4	Twin Scroll WG

Turbo Part Number	Turbo Frame Size	Super Core Part Number	Comp. Whl O.D. (in)	Comp. Whl Inducer Dia (in)	Comp. Whl O.D.(mm)	Comp. Whl Inducer Dia(mm)	Turb. Whl OD(mm)	Turb. A/R	Inlet Flange Config
179374	B1	179375	2.64	2.12	67.0	53.9	58.0	.92	T4